

SPEEDLITE 480EG

C50-0701,2

PARTS CATALOG

ATTENTION: these documentations are published only for purpose of study and search, they are not published for purpose of profit, all the rights and relative copyrights are of the respective owners. **Free documentation not to sell.**

CANON SPEEDLITE 480EG

REF No.C50-0701,2

1

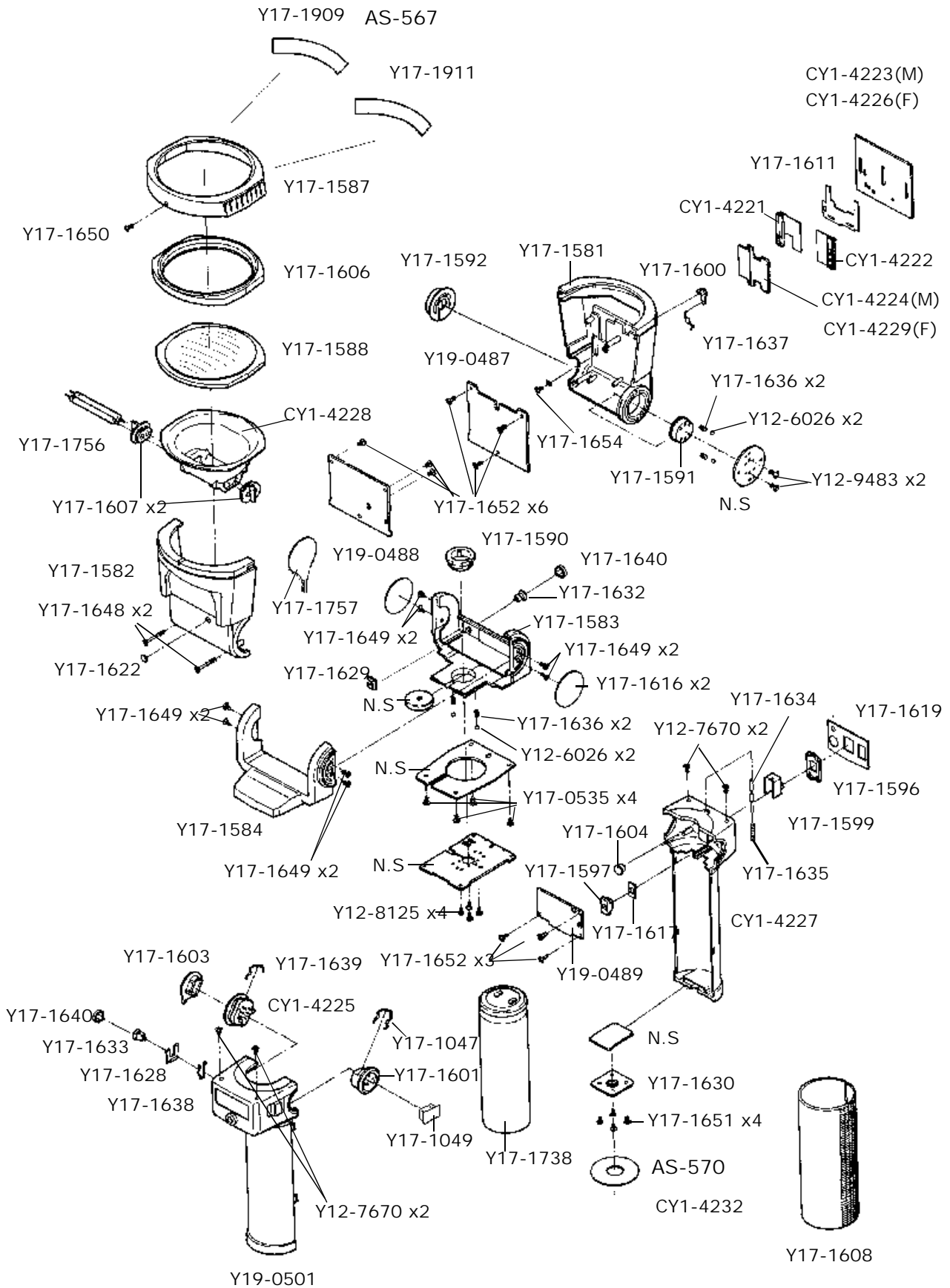

PARTS LIST

REF.NO.C50-0701,0702

Report.No.	NEW	PARTS NO.	CLASS	DESCRIPTION
		CY1-4221-000	E	COVER,AUTO SWITCH
		CY1-4222-000	D	KNOB, GNo.SW
		CY1-4223-000	D	PLATE,EXPOSURE INFO. (M)
		CY1-4224-000	E	BASE,ISO INFO. (M)
		CY1-4225-000	E	CONNECTOR,TTL UNIT
		CY1-4226-000	D	PLATE,EXPOSURE INFO. (Ft)
		CY1-4227-000	E	BODY(LA)
		CY1-4228-000	E	REFLECTOR UNIT
		CY1-4229-000	E	BASE,ISO INFO. (Ft)
AS-570		CY1-4232-000	D	COVER,GRIP END
		Y12-6026-000	D	BALL,CLICK
		Y12-7670-000		4 SCREW
		Y12-8125-000		4 SCREW
		Y12-9483-000		2 SCREW
		Y17-0535-000		4 SCREW
		Y17-1047-000	D	SPRING,CONNECTOR
		Y17-1049-000	E	CAP,BATTERY
		Y17-1581-000	E	BODY(UA)
		Y17-1582-000	C	BODY(UB)
		Y17-1583-000	E	BODY(CA)
		Y17-1584-000	E	BODY(CB)
		Y17-1587-000	D	RING,FRONT
		Y17-1588-000	E	PANEL
		Y17-1590-000	D	WHEEL,PIVOT(A)
		Y17-1591-000	E	WHEEL,PIVOT(B)
		Y17-1592-000	E	WHEEL,PIVOT(C)
		Y17-1596-000	E	COVER,KNOB
		Y17-1597-000	D	COVER,BEEPER SWITCH
		Y17-1599-000	E	KNOB,LOCK
		Y17-1600-000	E	LEVER
		Y17-1601-000	F	CONNECTOR,BATTERY
		Y17-1603-000	E	CAP,SENSOR
		Y17-1604-000	E	BUTTON,TEST
		Y17-1606-000	E	PACKING
		Y17-1607-000	E	RUBBER,BAND
		Y17-1608-000	D	COVERING,GRIP
		Y17-1611-000	E	PANEL,BLIND
		Y17-1616-000	E	PLATE,DECORATIVE
		Y17-1617-000	E	PLATE,SWITCH
		Y17-1619-000	E	PLATE, TEST/PILOT
		Y17-1622-000	E	PLATE, ADJUST

PARTS LIST

REF.NO.C50-0701,0702

Report.No.	NEW	PARTS NO.	CLASS	DESCRIPTION
		Y17-1628-000	E	NUT,SPEED
		Y17-1629-000	E	CLIP,SLAVE
		Y17-1630-000	E	SOCKET TRIPRD
		Y17-1632-000	D	TERMINAL,PC(SLAVE)
		Y17-1633-000	D	TERMINAL,PC
		Y17-1634-000	E	PIN,BOUNCE LOCK
		Y17-1635-000	E	SPRING,BOUNCE LOCK
		Y17-1636-000	E	SPRING(A)
		Y17-1637-000	E	SPRING
		Y17-1638-000	E	CLIP,PC
		Y17-1639-000	D	SPRING,SENSOR LOCK
		Y17-1640-000	D	CAP,PC
		Y17-1648-000		2 SCREW
		Y17-1649-000		8 SCREW
		Y17-1650-000		1 SCREW
		Y17-1651-000		4 SCREW
		Y17-1652-000		9 SCREW
		Y17-1654-000		1 SCREW
		Y17-1738-000	E	CAPACITOR,AL-EL
		Y17-1756-000	E	LAMP,XENON
		Y17-1757-000	E	BATTERY,LITHIUM
AS-567		Y17-1909-000	E	SEAL(METER),PANEL ADAPTOR
AS-567		Y17-1911-000	E	SEAL(FEET),PANEL ADAPTOR
		Y19-0487-000	E	A BOARD ASS'Y
		Y19-0488-000	E	C BOARD ASS'Y
		Y19-0489-000	E	D BOARD ASS'Y
		Y19-0501-000	E	BODY(LB) ASS'Y

PARTS LIST

REF.NO.C50-0701,0702

Report.No.	NEW	PARTS NO.	CLASS	DESCRIPTION
		C50-1771-000	D	WIDE PANEL 480EG-20
		C50-1781-000	D	TELE PANEL 480EG-135
		C50-1791-000	E	PANEL ADAPTER 480
		C50-1801-000	E	CLAMP EG
		C50-1811-000	E	BRACKET EG
		C50-1831-000	D	SYNCHRO CORD 480
AS-590		CY1-4250-000	D	SHOE CORD E
		(Y17-1818-000)	D	BASE, BRACKET

CANON SPEEDLITE 480EG (ACC)

5

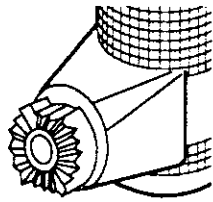

C50-1801 (CLAMP EG)

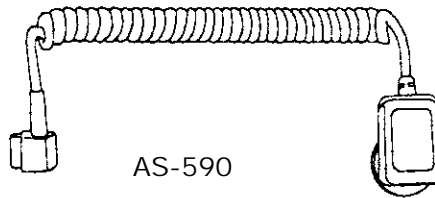

AS-590

CY1-4250(SHOE CORD E)



C50-1831 (SYNCRO CORD 480)

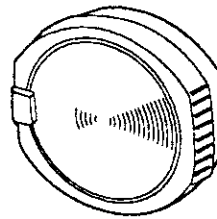

C50-1791 (PANEL ADAPTER 480)

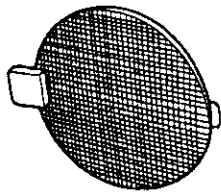

C50-1771 (WIDE PANEL 480EG-20)

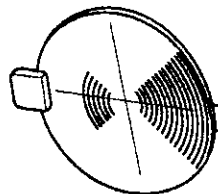

C50-1781 (TELE PANEL 480EG-135)

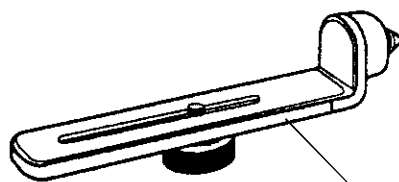

(Y17-1818)

C50-1811 (BRACKET EG)

ELECTRIC PARTS LIST

REF.NO.C50-0701,0702

Report.No. NEW	PARTS NO.	CLASS	QTY	DESCRIPTION
	VV1-1188-681		1	RESISTOR (R34/R35/R37/R38/R39/R40)
	Y17-1711-000		1	PT1(photo Tr)
	Y17-1729-000		1	IC3(PD17107LGS)
	Y17-1732-000		1	IC7(TA75393F)
	Y17-1734-000		1	IC5(S81250HG)
	Y17-1774-000		1	IC6(TC74HC4538AT)
	Y19-0491-000		1	LEAD UNIT(CN1)
	Y19-0492-000		1	LEAD UNIT(CN3)
	Y19-0493-000		1	LEAD UNIT(CN4)
	Y19-0494-000		1	LEAD UNIT(CN5)
	Y19-0495-000		1	LEAD UNIT(CN6)
	Y19-0496-000		1	LEAD UNIT(CN7)
	Y19-0497-000		1	LEAD UNIT(CN8)
	Y19-0498-000		1	LEAD UNIT(CN9)
	Y19-0499-000		1	LEAD UNIT(CN10)
	Y19-0500-000		1	LEAD UNIT(CN12)

ATTENTION: these documentations are published only for purpose of study and search, they are **not published for purpose of profit**, all the rights and relative copyrights are of the respective owners. **Free documentation not to sell.**